



London Taxis International  
Dismantling & De-pollution  
Manual for TXII Model

In accordance with Directive 2000/53/EC  
on End of Life Vehicle Disposal

## Vehicle Pre Treatment & Disassembly Manual

Manufacturer	London Taxis International
Vehicle	TX2
Date of Manufacture	January 2001 ⇒

Written by:	Paul Moore & Tim Oldland	Date:	07/11/2001
Approved by (Manager):	Colin Smith	Date:	07/11/2001
Approved by (Director):		Date:	
Initial Release	7/11/01		
Ref.:	F/End Of Life Vehicles/ Disassembly Manual TX2 issue 2		

Revisions		
Date	Actioned By	Change Description
17/9/02	Colin Smith	Contents page revised. Missing wts added. Raised to Revision 1.



## Vehicle Pre Treatment & Disassembly Manual

### Contents

<b>Sections</b>	<b>Description</b>	<b>Page No.</b>
0	Pre-treatment	3
1	Doors and Glazing	12
2	Exterior	30
3	Dashboard	32
4	Seats – No parts in this section	
5	Interior	37
6	Engine Compartment - No parts in this section	
7	Load Space - No parts in this section	

## 0 Pre-treatment

0.1 Battery

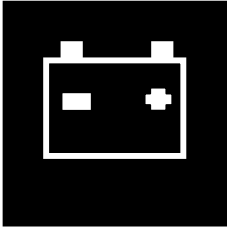

0.2 Airbag N/A



0.3 Refrigerant

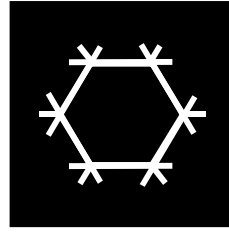

0.4 Haz.Mat/s N/A

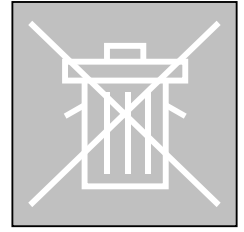

0.5a, b & c Fuel

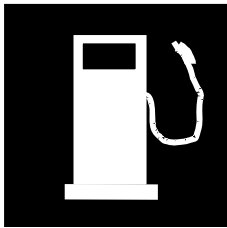

0.6a Engine oil



0. 6b, c, d, Oils

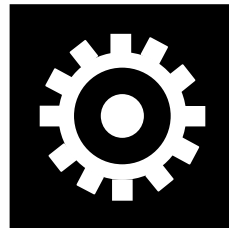

0.6 f Steering oil

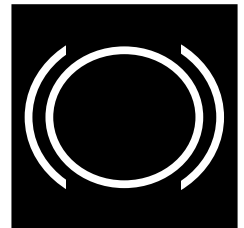

0.6e Damper oil

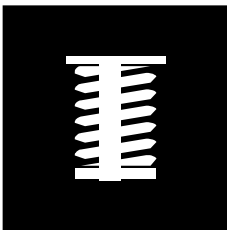

0.7 Brake fluid



0.8 Coolant

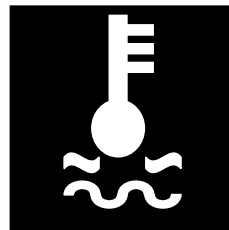

0.10 Wash fluid

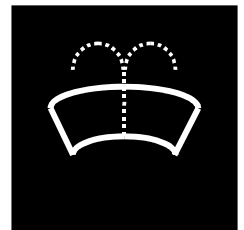

0.11 Tyres

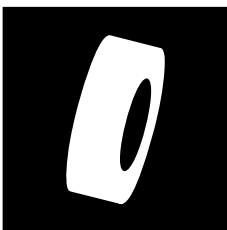



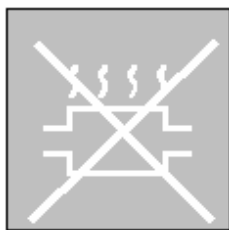

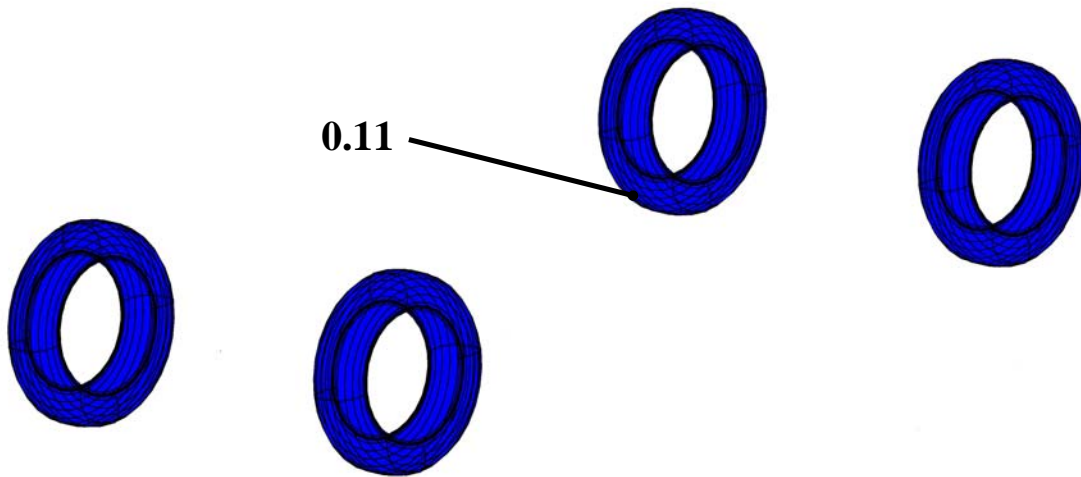

0.12 Catalyst

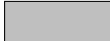

## 0 Pre-treatment

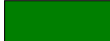

	ABS
	PA
	PE
	PMMA
	PP
	PVC
	PUR
	OTHER

## 0 Pre-treatment

Component	Battery	Reference:	0.1
Derivative	All variants	Quantity	1
Family		Weight	25.650kg
Materials	PE, Pb, Acid	Approx. Time	45
Obligations		Marked	

Fixings			
2	10 mm nut		

Tools		
10 mm spanner		

Method	
<p>The battery located in the engine compartment is to be removed immediately on arrival of the vehicle.</p> <p>Disconnect the negative terminal first then the positive terminal. Release the nuts that secure the clamping bar.</p>	

Comment	
<p>Warning! Wear protective clothing. Avoid skin contact with the battery fluid (acid).</p>	

Settings	

## 0 Pre-treatment

Component	Refrigerant	Reference:	0.2
Derivative	Optional	Quantity	1
Family		Weight	0.850 kg
Materials	R134A 1.1.1.2. Tetrafluoroethane	Approx. Time	1200
Obligations		Marked	

Fixings			

Tools	
Pressurisation equipment	
Suction equipment	

Method	
Undo the cap and attach suction equipment. Operate suction equipment.	

Comment	

Settings	

## 0 Pre-treatment

Component	Fuel	Reference:	0.5a
Derivative	All	Quantity	1
Family		Weight	50.22kg
Materials	Diesel fuel	Approx. Time	780 s
Obligations		Marked	

Fixings			
1	Drain plug		

Tools		
15/16"	spanner	

Method	
<p>Remove drain plug or pierce hole. Drain into container.</p> <p>Or use suction equipment.</p> <p>Seal up any holes to prevent dripping.</p>	

Comment	

Settings	

## 0 Pre-treatment

Component	Fuel tank	Reference:	0.5c
Derivative	All	Quantity	1
Family		Weight	4.75kg
Materials	Steel, Tin turn, Lead	Approx. Time	1min 25secs
Obligations		Marked	

Fixings			
4	Bolts		

Tools		
Spanner		

Method	
Drain tank. Cut fuel pipes. Remove 4 bolts. Disconnect filler neck. Drop out tank.	

Comment	

Settings	

## 0 Pre-treatment

Component	Engine oil	Reference:	0.6a
Derivative	All	Quantity	1
Family		Weight	4.22kg
Materials	Oil	Approx. Time	180 s
Obligations		Marked	

Fixings			
1	Drain plug		

Tools		
15/16"	spanner	

Method	
<p>Remove drain plug or pierce hole. Drain into container.</p> <p>Or use suction equipment.</p> <p>Seal up any holes to prevent dripping.</p> <p>Unscrew filter and drain.</p>	

Comment	

Settings	

## 0 Pre-treatment

Component	Oil filter	Reference:	0.6g
Derivative	All	Quantity	1
Family		Weight	1.22kg
Materials	Oil	Approx. Time	60 s
Obligations		Marked	

Fixings			
1	Oil filter spigot		

Tools		
Filter wrench		

Method	
Unscrew filter and drain.	

Comment	

Settings	

## 0 Pre-treatment

Component	Gear box oil	Reference:	0.6b
Derivative	Manual	Quantity	1
Family		Weight	1.660 kg
Materials	Oil	Approx. Time	300 s
Obligations		Marked	

Fixings			
1	Drain plug		

Tools		
1/2" square drive		

Method	
<p>Remove drain plug or pierce hole. Drain into container.</p> <p>Or use suction equipment.</p> <p>Seal up any holes to prevent dripping.</p>	

Comment	

Settings	

## 0 Pre-treatment

Component	Gear box oil	Reference:	0.6b
Derivative	Automatic	Quantity	1
Family		Weight	0.500 kg
Materials	Oil	Approx. Time	120 s
Obligations		Marked	

Fixings			
1	Drain plug		

Tools		
3/4" spanner		

Method	
<p>Remove drain plug or pierce hole. Drain into container.</p> <p>Or use suction equipment.</p> <p>Seal up any holes to prevent dripping.</p>	

Comment	

Settings	

## 0 Pre-treatment

Component	Differential oil	Reference:	0.6c
Derivative	All	Quantity	1
Family		Weight	1.700 kg
Materials	Oil	Approx. Time	180 s
Obligations		Marked	

Fixings			
1	Drain plug		

Tools			

Method	
<p>Remove drain plug or pierce hole. Drain into container.</p> <p>Or use suction equipment.</p> <p>Seal up any holes to prevent dripping.</p>	

Comment	

Settings	

## 0 Pre-treatment

Component	Shock absorber oil front	Reference:	0.6d
Derivative	All	Quantity	2
Family		Weight	1.700 kg
Materials	Oil	Approx. Time	
Obligations		Marked	

Fixings			

Tools	
Special equipment	

Method	
Use special equipment as instructed	

Comment	

Settings	

## 0 Pre-treatment

Component	Shock absorber oil rear	Reference:	0.6e
Derivative	All	Quantity	2
Family		Weight	2.480 kg
Materials	Oil	Approx. Time	
Obligations		Marked	

Fixings			

Tools	
Special equipment	

Method	
Use special equipment as instructed	

Comment	

Settings	

## 0 Pre-treatment

Component	Steering oil	Reference:	0.6f
Derivative	All variants	Quantity	1
Family		Weight	0.135 kg
Materials	Oil	Approx. Time	120 s
Obligations		Marked	

Fixings			

Tools	
Knife	
Screwdriver	

Method	
Cut pipes with the knife and remove reservoir. Remove sealed unit and reservoir invert and drain into appropriate storage container.	

Comment	

Settings	

## 0 Pre-treatment

Component	Brake fluid	Reference:	0.7a
Derivative	All variants	Quantity	1
Family		Weight	0.900 kg
Materials	Brake fluid	Approx. Time	120 s
Obligations		Marked	

Fixings			
	Bleed nipples		

Tools	
Suction equipment	
14 mm spanner	
8 mm spanner	

Method	
<p>Extract brake fluid from the reservoir by suction. Attach suction unit to each bleed nipple in turn. Open bleed nipple.</p>	

Comment	

Settings	

## 0 Pre-treatment

Component	Coolant	Reference:	0.8
Derivative		Quantity	1
Family		Weight	6.500 kg
Materials	Coolant	Approx. Time	30 s
Obligations		Marked	

Fixings			
	Hose clip		

Tools	
Knife	
Screwdriver	

Method	
<p>Position container under the radiator system. Release hose clip from the bottom of the radiator, remove the hose. Then release the coolant drain plug. Allow fluid to drain out.</p> <p>Remove the hose from the expansion tank and allow fluid to drain out.</p>	

Comment	

Settings	

## 0 Pre-treatment

Component	Wash fluid	Reference:	0.10
Derivative	All variants	Quantity	1
Family		Weight	4.000 kg
Materials	Wash fluid	Approx. Time	30 s
Obligations		Marked	

Fixings			

Tools	
Suction equipment	

Method	
Extract wash fluid from the reservoir by suction.	

Comment	

Settings	

## 0 Pre-treatment

Component	Tyres	Reference:	0.11
Derivative	All variants	Quantity	5
Family	Other	Weight	8.645 kg
Materials	Rubber, St	Approx. Time	165 s
Obligations		Marked	

Fixings			
6	Wheel nuts		

Tools	
27 mm socket	
Air driver	
Tyre stripping machine	







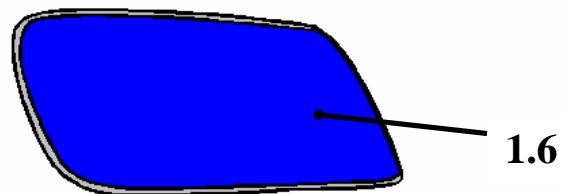
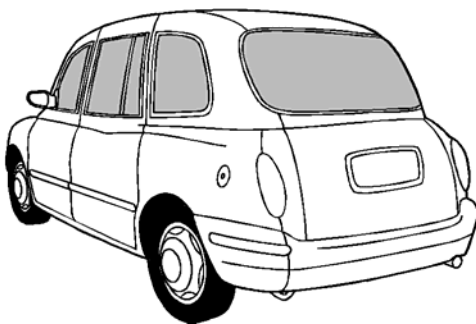
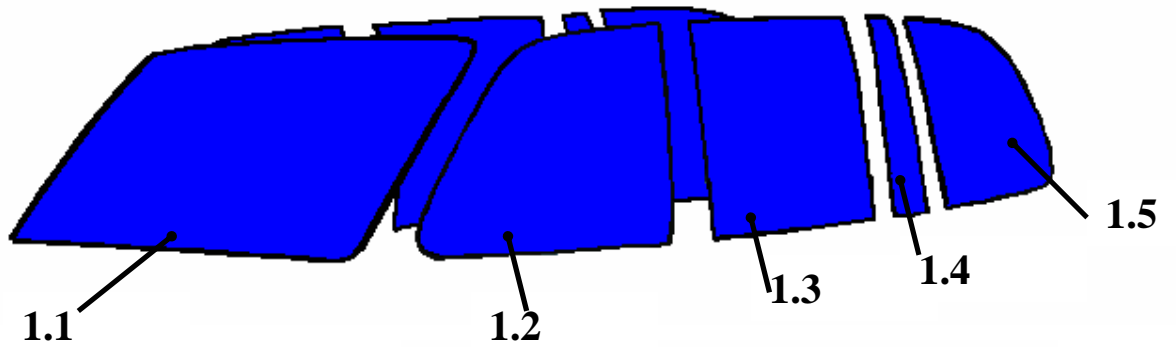
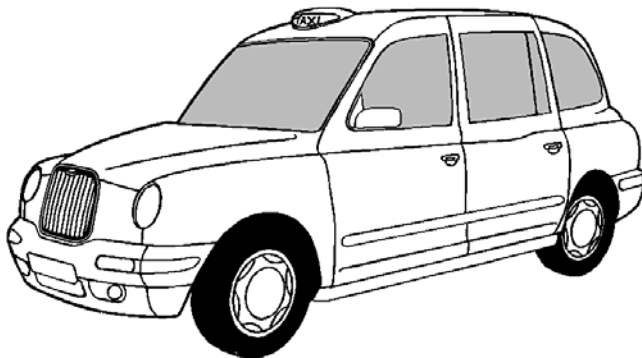

Method	
Release nuts and detach wheel. Remove tyre from wheel rim.	

Comment	

Settings	







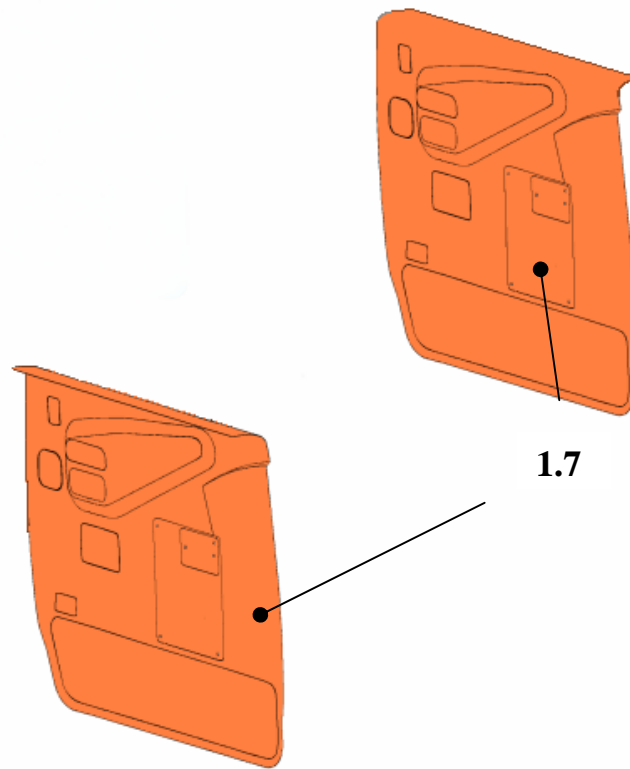

## 1 Doors and Glazing



	ABS
	PA
	PE
	PMMA
	PP
	PVC
	PUR
	OTHER

## 1 Doors and Glazing



	ABS
	PA
	PE
	PMMA
	PP
	PVC
	PUR
	OTHER

## 1 Doors and Glazing

Component	Front Windscreen	Reference:	1.1
Derivative		Quantity	1
Family	Glass	Weight	10.744 kg
Materials	Glass/ PVB	Approx. Time	120 s
Obligations		Marked	

Fixings	
Rubber cosmetic seal	
Bonded seal	

Tools	
Kent windscreen knife	

Method	
<p>Remove external cosmetic seal.</p> <p>Insert knife between body and glass, run the knife around the perimeter of the screen.</p> <p>Lift out screen.</p>	

Comment	

Settings	

## 1 Doors and Glazing

Component	Front door window	Reference:	1.2
Derivative		Quantity	2
Family	Glass	Weight	3.475 kg
Materials		Approx. Time	60 s
Obligations		Marked	

Fixings	
Bonded seal	

Tools	
Kent windscreen knife	

Method	
<p>Remove external cosmetic seal.</p> <p>Insert knife between body and glass, run the knife around the perimeter of the screen.</p> <p>Lift out screen.</p>	

Comment	

Settings	

## 1 Doors and Glazing

Component	Rear door window	Reference:	1.3
Derivative		Quantity	2
Family	Glass	Weight	3.588 kg
Materials	Glass	Approx. Time	60 s
Obligations		Marked	

Fixings	
Bonded seal	

Tools	
Kent windscreen knife	

Method	
<p>Remove external cosmetic seal.</p> <p>Insert knife between body and glass, run the knife around the perimeter of the screen.</p> <p>Lift out screen.</p>	

Comment	

Settings	

## 1 Doors and Glazing

Component	Rear door fixed side light	Reference:	1.4
Derivative		Quantity	2
Family	Glass	Weight	0.661 kg
Materials	Glass	Approx. Time	60 s
Obligations		Marked	

Fixings	
Rubber cosmetic seal	
Bonded seal	

Tools	
Kent windscreen knife	

Method	
<p>Remove external cosmetic seal.</p> <p>Insert knife between body and glass, run the knife around the perimeter of the screen.</p> <p>Lift out screen.</p>	

Comment	

Settings	

## 1 Doors and Glazing

Component	Rear quarter light	Reference:	1.5
Derivative		Quantity	2
Family	Glass	Weight	2.324 kg
Materials	Glass	Approx. Time	60 s
Obligations		Marked	

Fixings	
Rubber cosmetic seal	
Bonded seal	

Tools	
Kent windscreen knife	

Method	
<p>Remove external cosmetic seal.</p> <p>Insert knife between body and glass, run the knife around the perimeter of the screen.</p> <p>Lift out screen.</p>	

Comment	

Settings	

## 1 Doors and Glazing

Component	Rear Windscreen	Reference:	1.6
Derivative		Quantity	1
Family	Glass	Weight	6.090 kg
Materials	Glass	Approx. Time	60 s
Obligations		Marked	

Fixings	
Rubber cosmetic seal	
Bonded seal	

Tools	
Kent windscreen knife	

Method	
<p>Remove external cosmetic seal.</p> <p>Insert knife between body and glass, run the knife around the perimeter of the screen.</p> <p>Lift out screen.</p>	

Comment	

Settings	

## 1 Doors and Glazing

Component	Rear door casing	Reference:	1.7
Derivative		Quantity	2
Family	ABS	Weight	2.27
Materials	ABS	Approx. Time	60s
Obligations		Marked	

Fixings			
3	Self tapping screw		
2	M8 cap head screw		
1	Pin		
	Firtree		

Tools	
Phillips screwdriver	
Allen key	
Flat blade screwdriver	







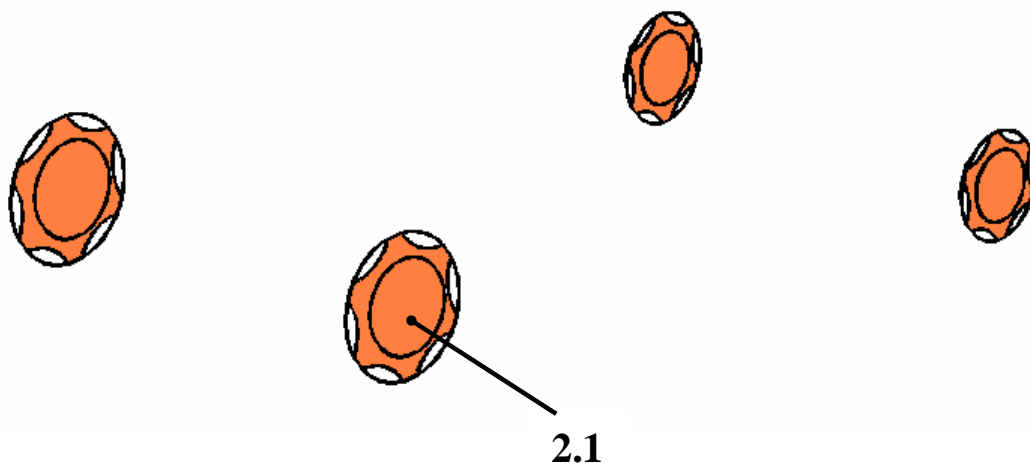

Method	
Remove check strap by pushing and turning until it pops out. Remove self-tapping screws, cap head screws, grab handle and interior door lock surround. Lever off door trim to disengage fir trees.	

Comment	

Settings	

## 2 Exterior



	ABS
	PA
	PE
	PMMA
	PP
	PVC
	PUR
	OTHER

## 2 Exterior

Component	Wheel trim	Reference:	2.1
Derivative	All Variants	Quantity	4
Family	ABS	Weight	0.52kg
Materials	ABS, Steel Rim	Approx. Time	15 s
Obligations		Marked	

Fixings			
1	Push Fit		

Tools	
None	







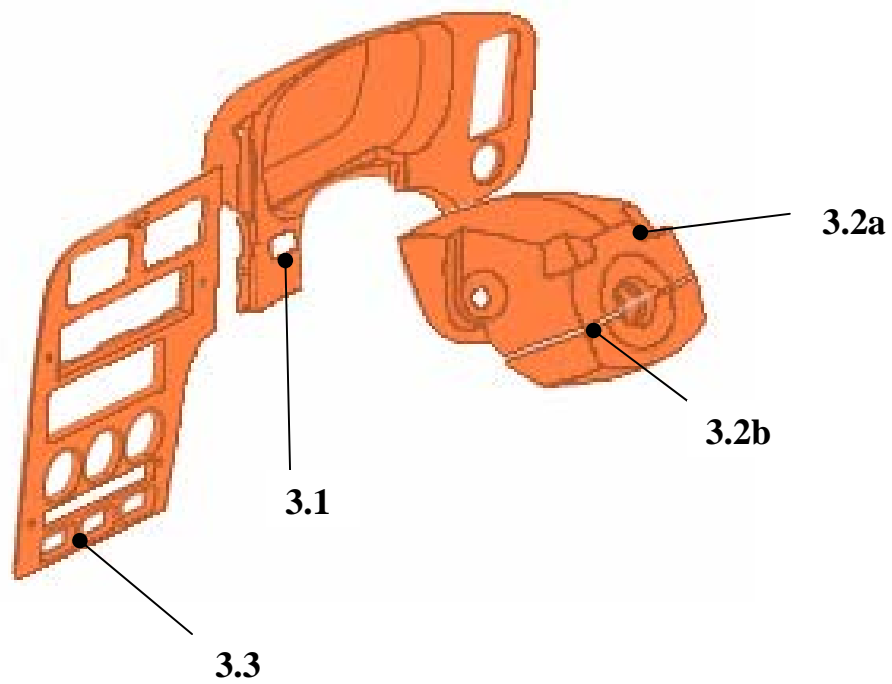
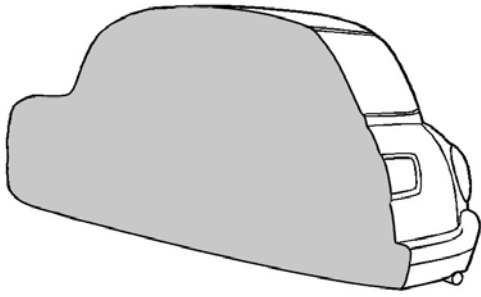

Method	
<p>Pull Trims off wheels.</p> <p>Pull Steel rim away from plastic part.</p>	

Comment	

Settings	

### 3 Dashboard



	ABS
	PA
	PE
	PMMA
	PP
	PVC
	PUR
	OTHER

### 3 Dashboard

Component	Instrument Surround	Reference:	3.1
Derivative	All variants	Quantity	1
Family		Weight	0.167kg
Materials		Approx. Time	
Obligations		Marked	

Fixings			
2	Screws		

Tools		
Phillips head screwdriver		

Method	
Remove screws and pull off binnacle. Disconnect wires.	

Comment	

Settings	

### 3 Dashboard

Component	Steering cowl upper	Reference:	3.2a
Derivative		Quantity	1
Family		Weight	0.06kg
Materials		Approx. Time	40 sec
Obligations		Marked	

Fixings			
4	Screws		

Tools		
Phillips head screw driver		

Method	
Remove screws and pull off upper and lower cowl.	

Comment	

Settings	

### 3 Dashboard

Component	Steering cowl lower	Reference:	3.2b
Derivative		Quantity	1
Family		Weight	0.152 kg
Materials		Approx. Time	0 secs (see Upper Cowl)
Obligations		Marked	

Fixings			
	See Upper Cowl		

Tools	
See Upper Cowl	

Method	
See Upper Cowl	

Comment	

Settings	

### 3 Dashboard

Component	Switch Surround Panel	Reference:	3.3
Derivative		Quantity	1
Family		Weight	0.174 kg
Materials		Approx. Time	10 sec
Obligations		Marked	

Fixings			
2	Screws		

Tools		
Phillips head screw driver		







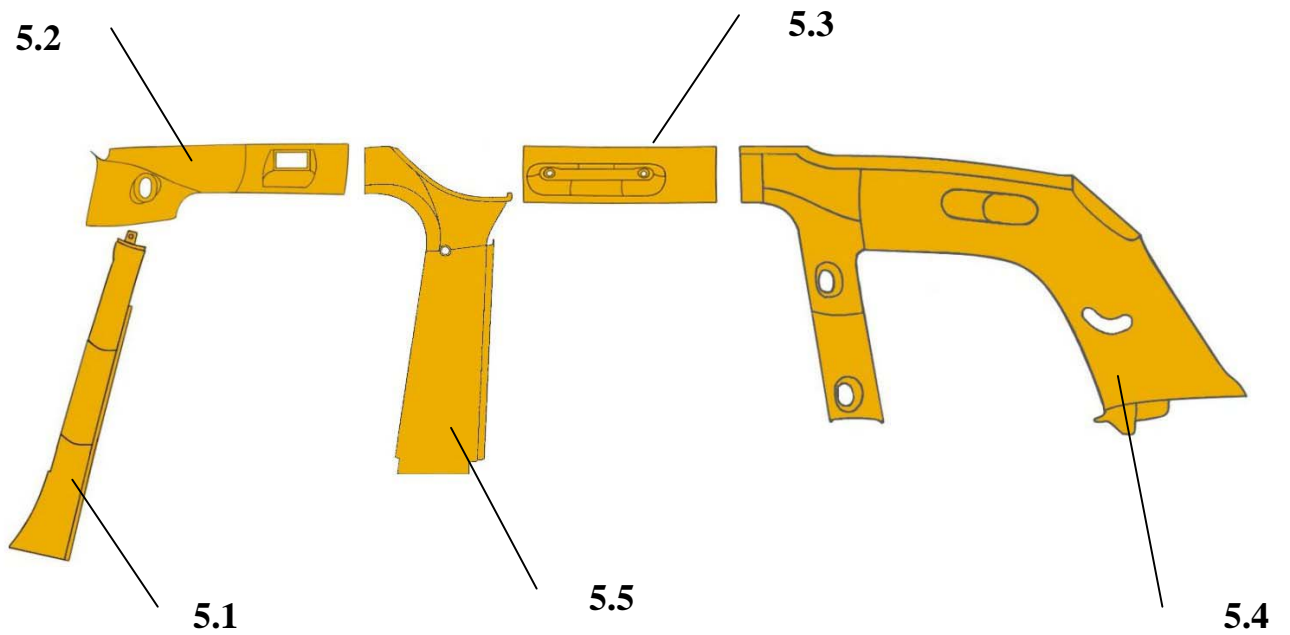
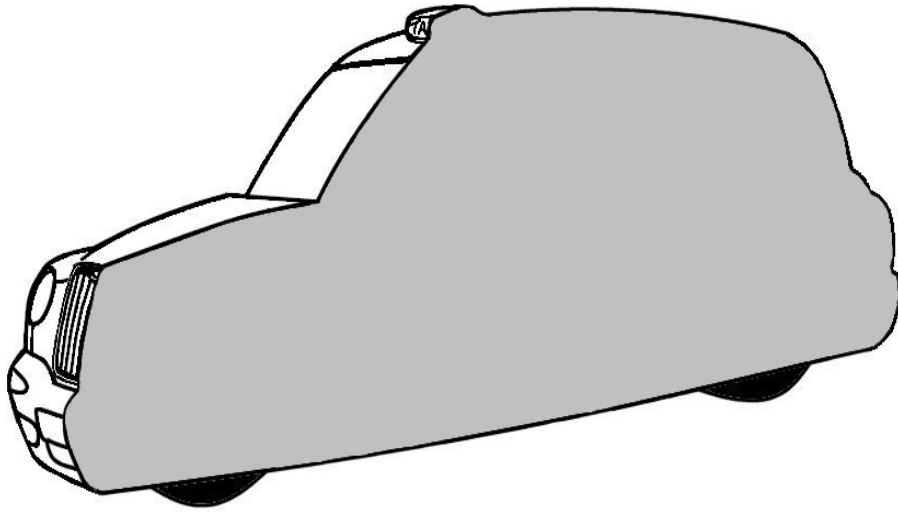

Method	
Remove screws and pull out instrument panel	

Comment	

Settings	

## 5 Interior



	ABS
	PA
	PE
	PMMA
	PP
	PVC
	PUR
	OTHER

## 5 Interior

Component	A pillar finisher	Reference:	5.1
Derivative	All variants	Quantity	2
Family	ABS	Weight	0.217 kg
Materials	ABS	Approx. Time	10 sec
Obligations		Marked	

Fixings		
	Fir trees	

Tools	
Crowbar	

Method	
Lever trim with crow bar to disengage fixings.	

Comment	

Settings	

## 5 Interior

Component	Cantrail finisher front	Reference:	5.2
Derivative	All variants	Quantity	2
Family	ABS	Weight	0.315 kg
Materials	ABS	Approx. Time	15 s
Obligations		Marked	

Fixings			
2	Self tapping screws		
	Fir trees		

Tools	
Screwdriver	
Crowbar	

Method	
Remove sun visor screws and sun visors. Lever off cantrail to disengage fir trees. Disconnect interior lamp.	

Comment	

Settings	

## 5 Interior

Component	Rear cantrail finisher	Reference:	5.3
Derivative	All variants	Quantity	2
Family	ABS	Weight	0.285 kg
Materials	ABS	Approx. Time	15 s
Obligations		Marked	

Fixings			
2	Cap head screw		
	Fir trees		

Tools	
Allen key	
Crowbar	

Method	
Remove cap head screws and lever off the panels.	

Comment	

Settings	

## 5 Interior

Component	Rear quarter upper trim panel	Reference:	5.4
Derivative	All variants	Quantity	2
Family	ABS	Weight	1.306 kg
Materials	ABS	Approx. Time	45 s
Obligations		Marked	

Fixings			
2	Cap head screws		
	Fir trees		

Tools	
Allen key	
Crowbar	
Knife	

Method	
Remove cap head screws, cut seat belt insert and lever off trim.	

Comment	

Settings	

## 5 Interior

Component	B pillar finisher	Reference:	5.5
Derivative	All variants	Quantity	2
Family	ABS	Weight	0.271kg LH 0.387kg RH
Materials	ABS	Approx. Time	15 s
Obligations		Marked	

Fixings			
2	Screws		

Tools	
Screwdriver	

Method	
Remove division glass, unscrew and remove trim panel.	

Comment	

Settings	